

# DIMENSIONI D' INGOMBRO passaggio di paratia

Sigla **PPC 3"**

In vigore dal: 01-01-1981

Sostituita da:

Codice: **90-9001703**

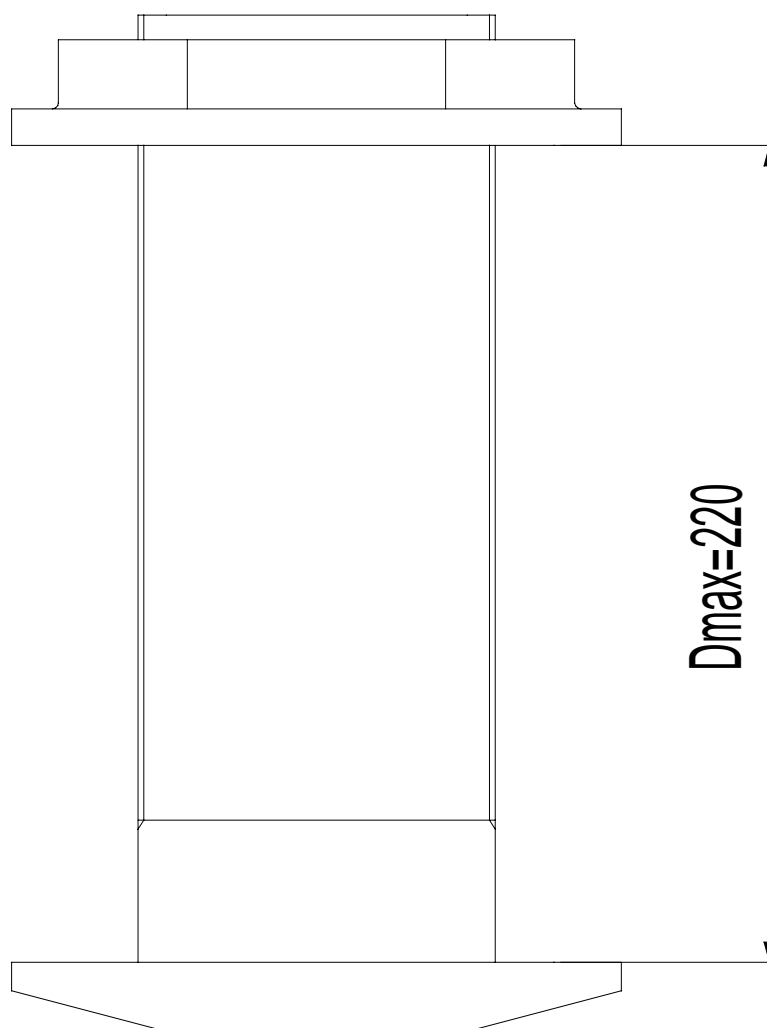

Dimensioni flangia su canotto

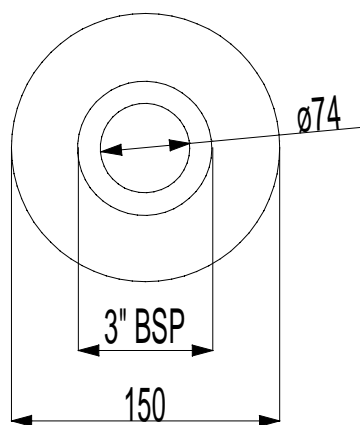

Dimensioni dado di serraggio

