

DIMENSIONI D' INGOMBRO

Sigla 3V40

In vigore dal: 01-01-1978

Sostituita da:

Codice: 90-9001101

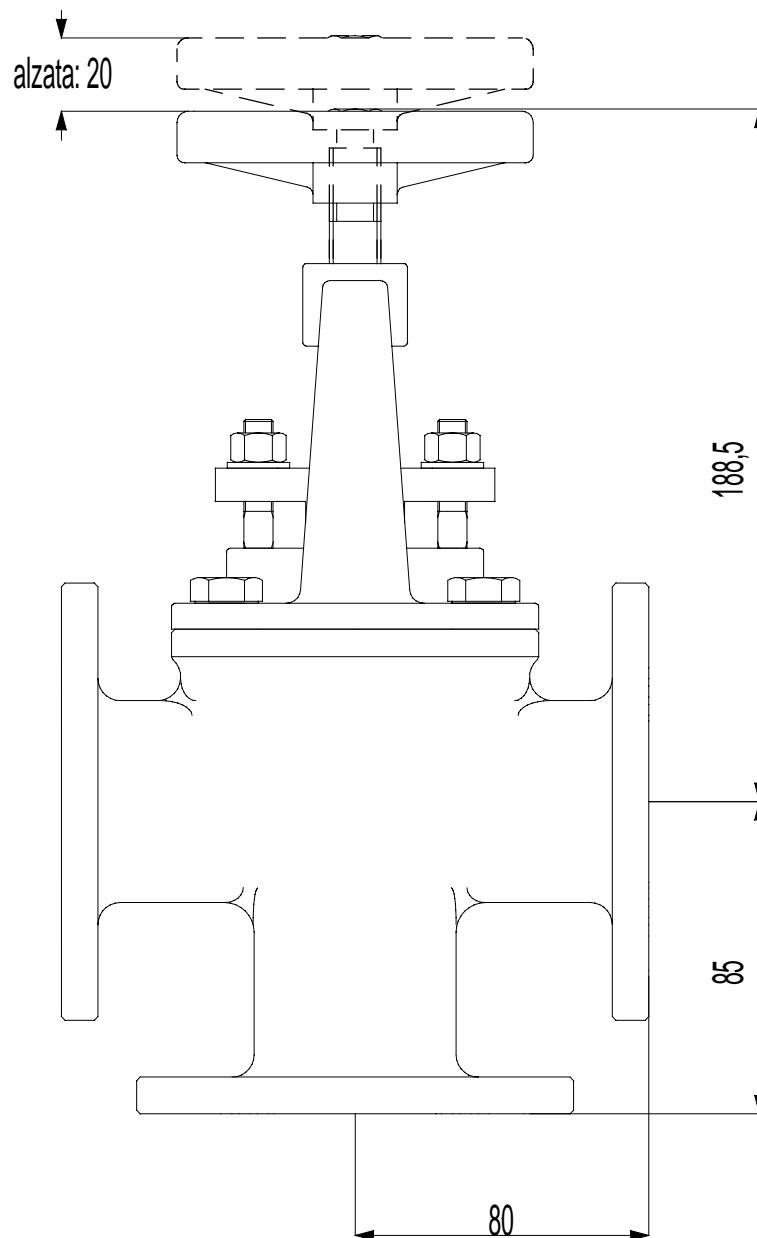

Dimensioni flange

